



Installation Instructions

Instructions for Connecting PETROSMART EZ Control Systems to Gilbarco Electronic Dispensers With/Without CRIND CREDIT CARD MODULES

Read This Book

This book has important information for safe installation and operation of this equipment. Read and understand this book before applying power. Keep this book and tell all service personnel to read this book. If you do not follow the instructions, you can cause damage to the equipment, injury, or death.

Triangle MicroSystems Inc.
1807 Garner Station Blvd.
Raleigh, N.C. 27603
(919) 878-1880 <http://www.trianglemicrosystems.net>

PetroSmart EZ Control System

Table of Contents

SECTION

1. Dangers Warnings and Precautions	Pg. 3
2. System Requirements	Pg. 4
3. System Description	Pg. 5
4. PetroSmart EZ System Diagram	Pg. 6
5. Gilbarco Interconnect Boxes	Pg. 7
6. Connection of Interconnect Box, Data Wires	Pg. 8
7. PetroSmart EZ Converter Board	Pg. 9
8 Power Requirements	Pg. 10
9. Cable Connections	Pg. 11
10. Important Notes	Pg. 13
11. Specifications	Pg. 14
12. TMS Service and Warranty Information	Pg. 15
13. Warranty Information	Pg. 16

I. Dangers, Warnings and Precautions

FOR THE SAFE INSTALLATION, MAINTENANCE, AND OPERATION OF THIS CONSOLE AND RELATED EQUIPMENT, READ AND UNDERSTAND ALL WARNINGS AND CAUTIONS.

"DANGER": means: If you do not follow the instructions, severe injury or death will occur.

"WARNING": means: If you do not follow the instructions, severe injury or death can occur.

"CAUTION": means: If you do not follow the instructions, damage can occur to the equipment.

"DANGER": Disconnect all power to this equipment and associated dispensers equipment during installation, service or any maintenance. Failure to do so can cause injury or damage to the equipment.

"WARNING": Maintenance and repairs must be done by **QUALIFIED/TRAINED** personnel.

"WARNING": To prevent electric shock, keep the electrical parts of the console dry.

"WARNING": You must have training in the installation and service of fuel dispensing equipment before working on this system.

"WARNING": Make sure this equipment is correctly grounded. Failure to do so can cause injury or damage equipment.

"CAUTION": Electronic components are static sensitive. Use proper static precautions (static straps) before working on the equipment.

"WARNING": Failure to properly ground all equipment can cause injury or damage equipment.

"WARNING": Installation must comply with National Code (NFPA #70), Automotive and Marine Service Code (NFPA #30A), Federal, State and local codes.

"CAUTION": This equipment generates and uses radio frequency energy. If not installed and used properly, i.e., in strict accordance with the instructions in this manual, it may cause interference to radio communications. The console was tested and found to comply with the limits for a Class A computing device in accordance with Sub-part J of Part 15 of the FCC Rules. A Class A computing device is designed to provide reasonable protection against interference when operated in commercial environment.

"CAUTION": Follow proper grounding procedures to reduce radio frequency interference (RFI). Ground each piece of equipment connected to, or controlled by, the console to the electrical service panel ground.

"CAUTION": Each dispenser must have a 12 gauge or larger green stranded ground wire connected from the grounding lug of the junction box to the main electrical service panel ground. (National Electrical Code, Article 514-7). It is unacceptable to rely on the conduit for this grounding requirement.

2. System Requirements

In developing the Triangle MicroSystems control system for Gilbarco dispensers with CRIND credit card module, Gilbarco provided the communication protocols that required **separate data wires** for the CRIND credit card modules and the dispensers. This is Gilbarco standard policy for “third party” control systems. Secondly, the TMS control system **does not require** the Gilbarco PIB board to interface with the dispensers. The CRIND credit card module and dispenser control data wires coming directly from the equipment are connected to separate TMS interface boxes. Therefore, to install the TMS PetroSmart control system and operate the CRIND credit card modules a single pair of data wires must be run to each Gilbarco CRIND credit card module. The cable required must be a **shielded, single twisted pair conductor**.

Installations will vary from site to site in terms of the electrical interference induced into the CRIND credit card module data wires. The cable shield when connected to the ground screw on the TMS PetroSmart interface power supply will significantly reduce the electrical interference.

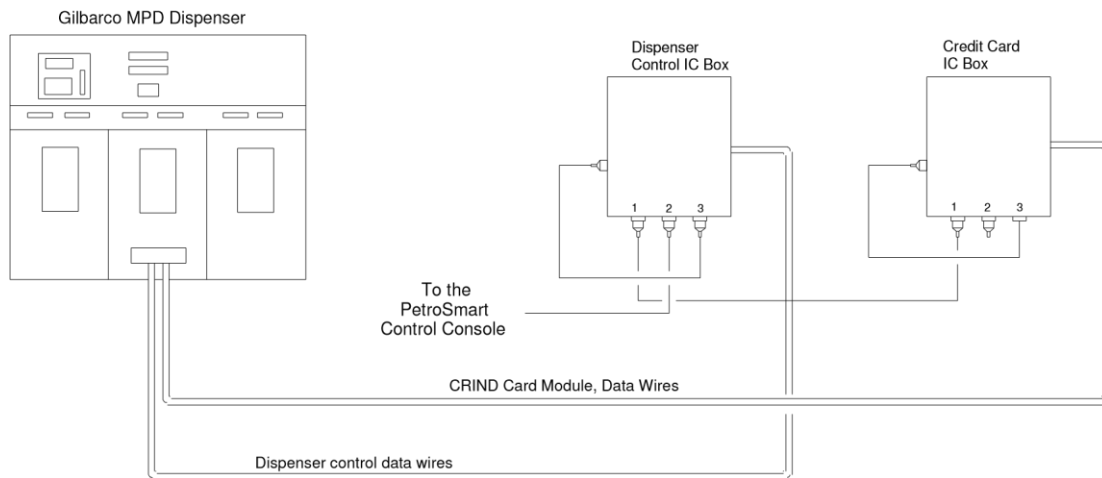

Fig. 1, PetroSmart Data Wire Diagram

3. System Description

The PETROSMART EZ fuel control system for GILBARCO dispensers is designed to control VISTA electronic dispensers/blenders with CRIND credit card modules.

The PETROSMART EZ dispenser control system is comprised of the following items:

Qty.	Description
1	PETROSMART EZ Console.
1	PETROSMART EZ Gilbarco dispenser control, IC box.
1	PETROSMART EZ Gilbarco CRIND credit card module IC box.
1	PETROSMART EZ 1500 credit card terminal.
4	PETROSMART EZ cables. 1– 25', Console to IC Box 1-- 3', IC Box to IC Box 2—1.5', IC Box Cables (Already Connected)

Optional UPS (Un-interruptible Power Supply)
(Recommended)

Fueling Positions

The maximum number of fueling positions permissible is **8** for a PETROSMART EZ-8 or **16** for a PETROSMART EZ-16, where each side of an MPD (no matter how many grades) counts as one fueling position.

4. PetroSmart EZ System Diagram

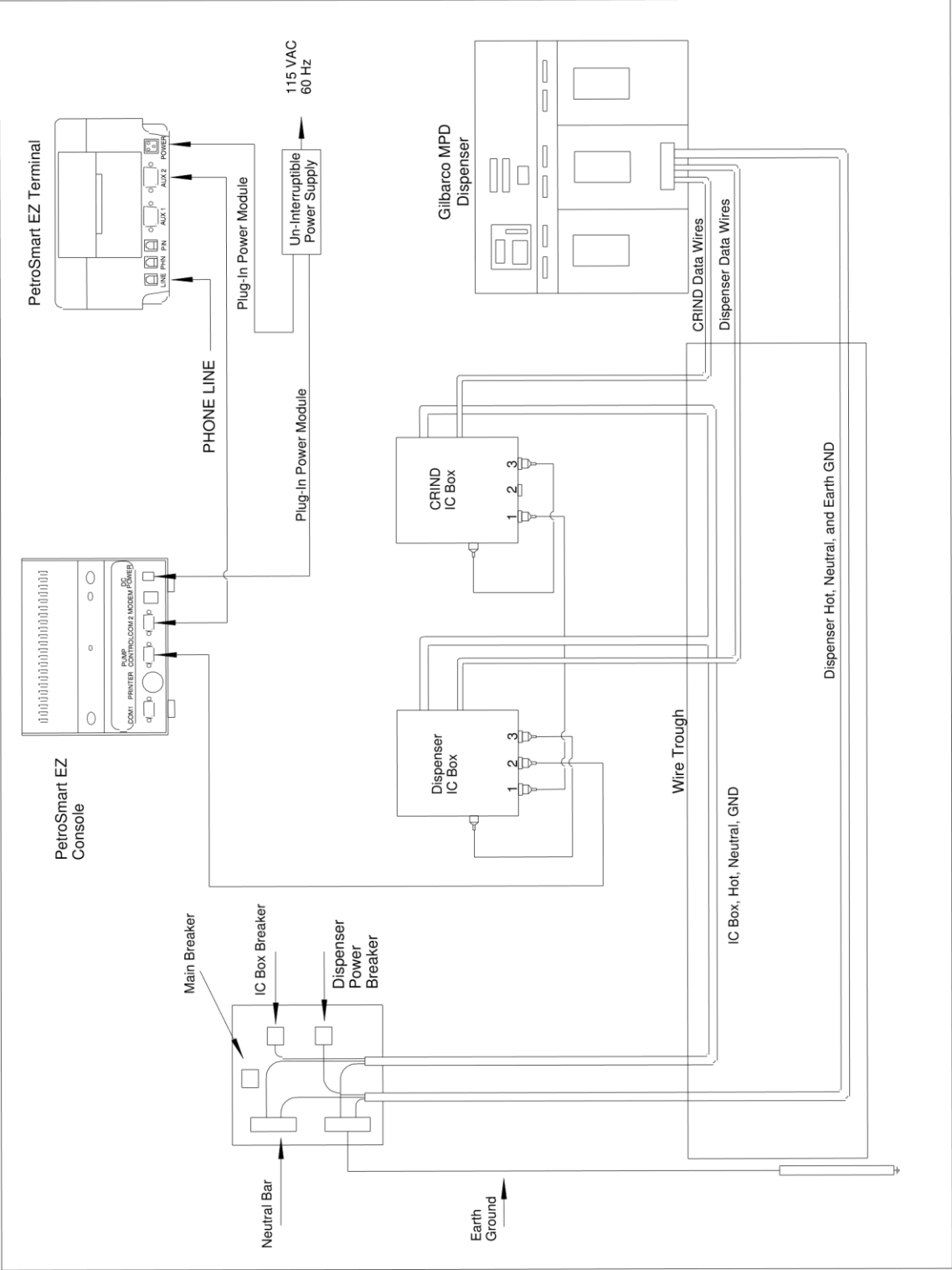

Fig. 2, PetroSmart EZ System Diagram

5. GILBARCO Interconnect Boxes

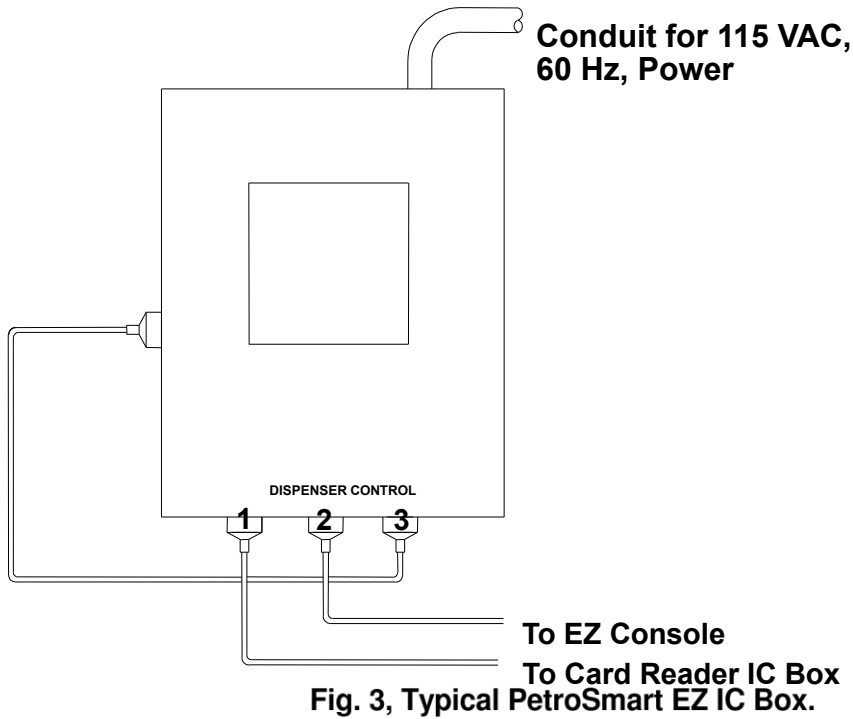

Fig. 3, Typical PetroSmart EZ IC Box.

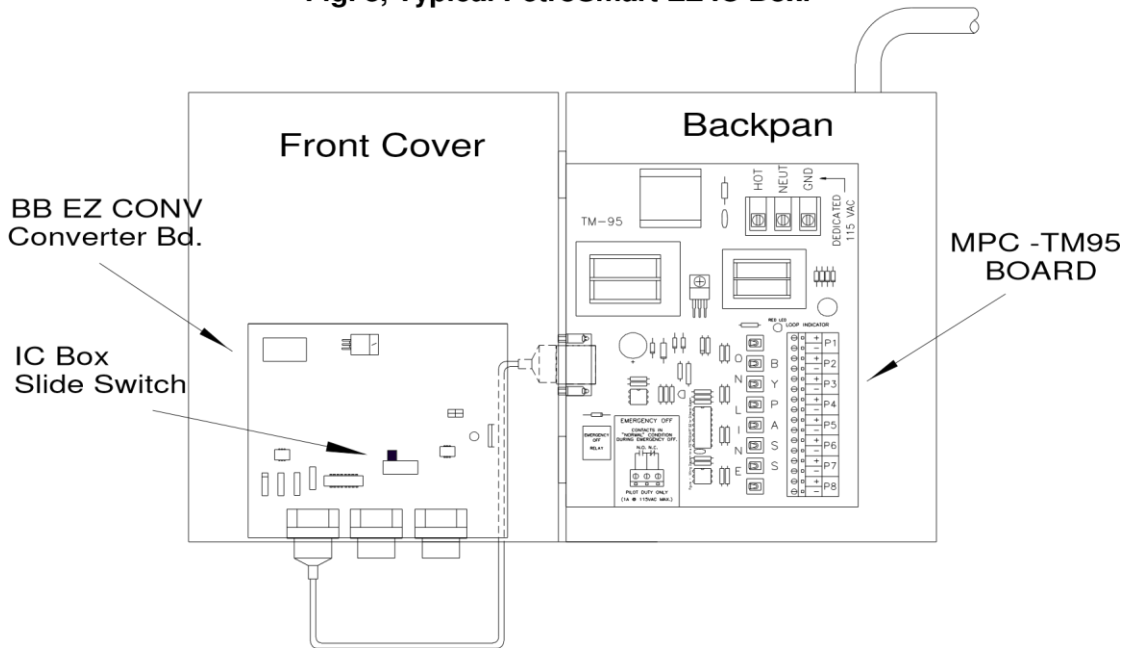

Fig. 4, The PetroSmart EZ Gilbarco Interconnect Box with the Door Open.

The PETROSMART EZ Gilbarco dispenser and CRIND interconnect boxes include the MPCTM95 communication board and the EZ-E-CONV converter board. The MPC-TM95 communication board/power supply receives the incoming line voltage (120 VAC), supplies the operating system with DC voltage. The dispenser IC box transmits data signals between the console and the dispenser.

6. Connection of Interconnect Box, Data Wires

NOTE: Both the “Dispenser IC Box” and the “Card Reader IC Box” are identical, however, the interconnect boxes are labeled accordingly to simplify installation and servicing. Do not mix the dispenser control and credit card control data wires.

NOTE: Do not mix the dispenser control and credit card control data wires.

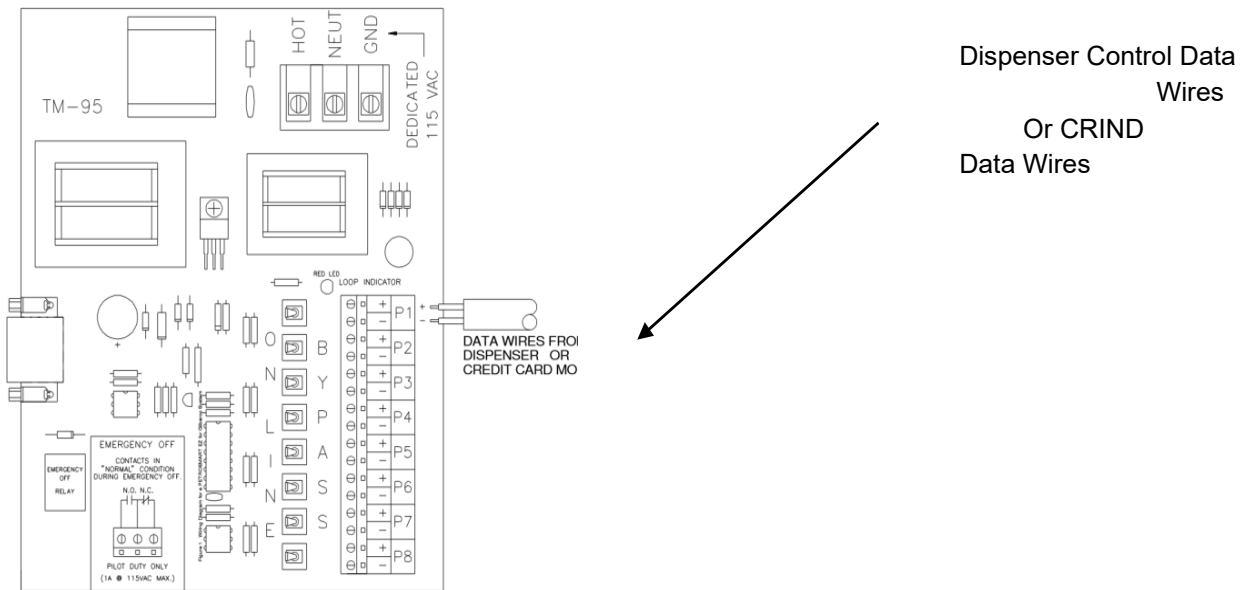

Fig. 5, Interconnect Box, MPC-TM95 Board

The PETROSMART EZ-16 console can control up to 16 fueling positions. It is possible that more than four sets of dispenser data wires might be connected to the PETROSMART MPC-TM95 terminal strip. In this case, two sets of data wires can be connected to any position as shown in Fig. 6, below.

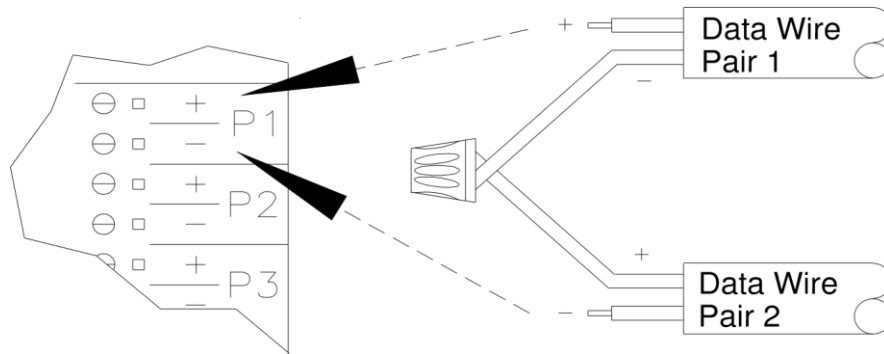

Fig. 6, How to Connect, Dispenser Control Data Wires

7. PETROSMART EZ Converter Board

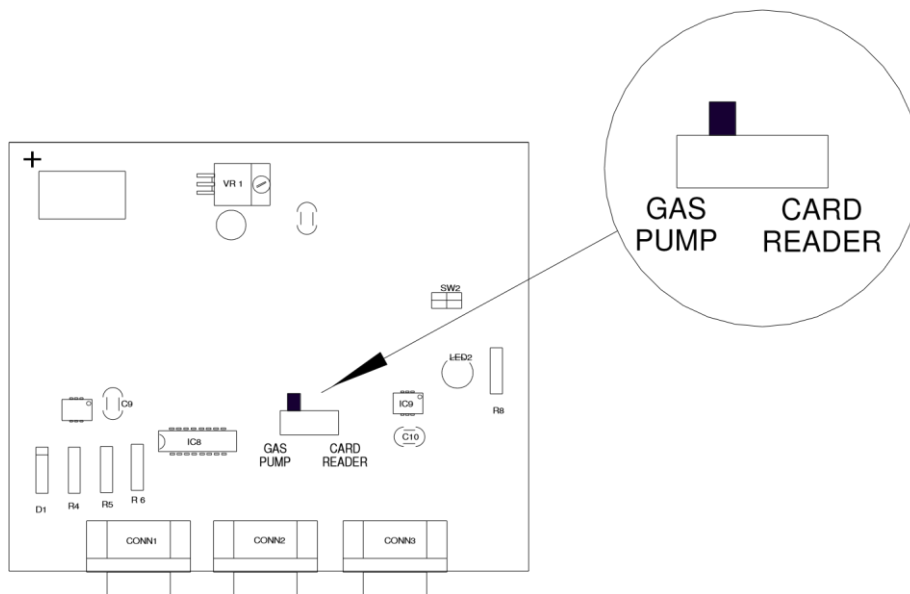

Fig. 10, PETROSMART EZ Converter Board

The converter board is located on the inside cover of both the dispenser control IC box and the credit card control IC box, refer to Fig. 4, pg 5 and Fig.7, pg. 7.

IMPORTANT -After installation of both IC boxes check the slide switch on the converter board (Refer to Fig. 10) for the proper switch position. In the IC box that is connected to the **dispenser** data wires the slide switch must be positioned on the end marked **“GAS PUMP”**.

The IC box that is attached to the **CRIND credit card module** data wires must have the slide switch positioned on the end marked **“CARD READER”**.

8. Power Requirements

CONNECTION INSTRUCTIONS FOR THE SYSTEM POWER SUPPLY, DISPENSER, MOTOR, AND ELECTRICAL GROUND CIRCUITS.

A.C. POWER REQUIREMENTS

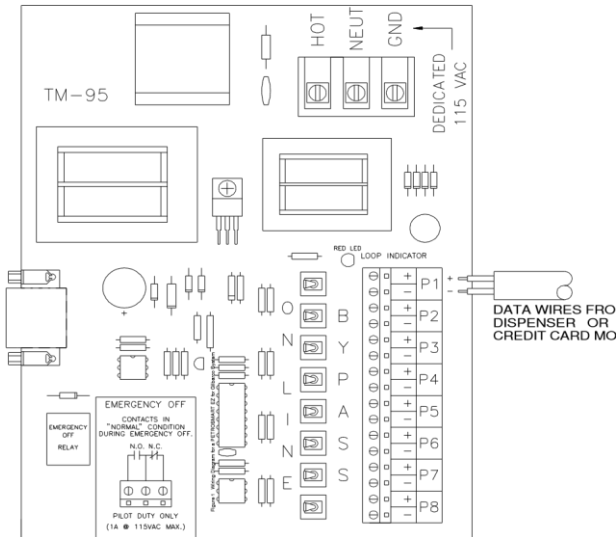

1. Breaker Panel: A 125 Amp breaker is the minimal allowable electrical service for the pump motor and interface boxes, dispensers, canopy lights and advertising signs.

2. The PETROSMART EZ, Gilbarco dispenser and CRIND credit card module IC box, both require a 115VAC, 15 Amp **DEDICATED** breaker (with no other devices or outlets connected to it) for connection to the MPC-TM84E board. Make sure the correct voltage and frequency are present. All AC wires must be 14 gauge (min.), and in conduit. Do not put wiring from other

sources in this conduit.

- 3. PETROSMART EZ Console:** The console is powered by a standard plug-in AC Adaptor power module. The Adaptor can be inserted into a standard electrical outlet that supplies, 115VAC, 60Hz, 15W power. The Adaptor converts the input to 15 VDC, 600mA which it supplies to the EZ console. A UPS is supplied with then system to minimize disruption in the event of a general power failure.
- 4. Dispensers:** The dispensers' installation guide shows all requirements including, but not limited to breakers, wires to supply data signals to the electronics, green wire for Earth Ground, and wires to power the dispenser and fluorescent lighting. Refer to the installation manual for the dispenser being installed for complete installation requirements.
- 5. Pump Motor:** Use auxiliary relays, correct gauge wires, and 115/230VAC breakers to supply power to the pump motors. Refer to the installation manual of the equipment being used for complete installation requirements, drawings, and special notes for proper installation.

9. Cable Connections

The connection between the PETROSMART EZ console and the interconnect box marked “DISPENSER CONTROL” is made via a 25 foot round cable having 15-conductors and DB-15 type connectors.

The connection to the “CARD READER CONTROL” box is via a 3 foot, 15-conductor, DB-15 cable which connects the “CARD READER CONTROL” box to the “DISPENSER CONTROL” interconnect box. Refer to Fig. 2, page 6 of this manual.

Longer cables are available to fit the particular needs of the installation site. The maximum recommended distance between the PETROSMART EZ Console and the PETROSMART EZ, “DISPENSER CONTROL” interconnect box is 150 feet.

Note: A 24” cable comes already attached to each interconnect box, which provides system integration of the dispenser control and credit card control communications. This cable, which comes already attached to each respective IC box, should not be removed during the installation of the PETROSMART EZ system.

INSTALLING THE PETROSMART EZ CONSOLE

1. Make sure that all system component connections and cables are properly assembled before turning on the power to any of the components.
2. Mount all interconnect boxes near the wire trough, or where the conduit from the pumps/dispensers enters the building.
3. Place the console in a location that allows an unobstructed view of all fueling positions at the site.

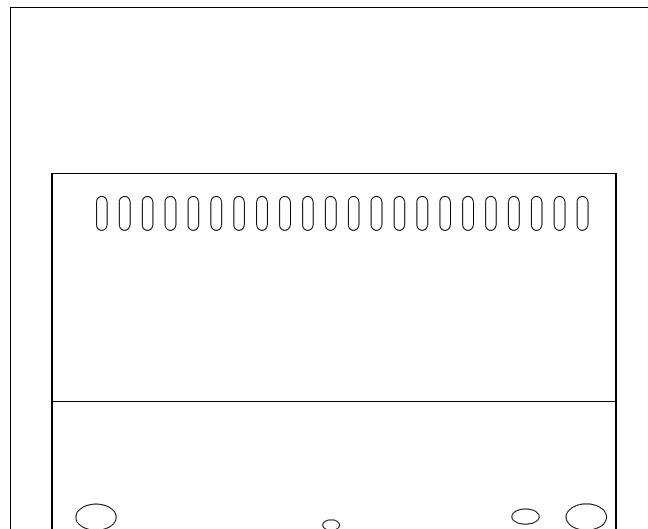

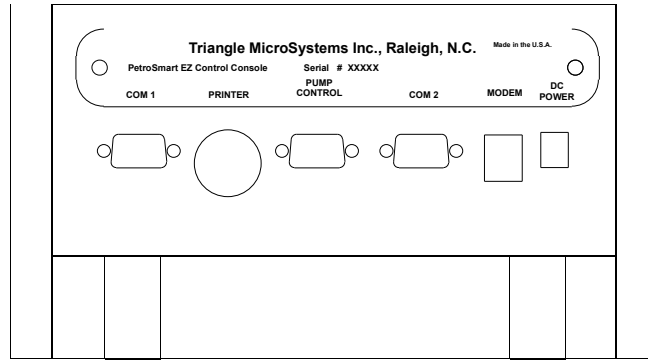

Fig. 12, Back View of the PetroSmart EZ Console

4. **Connecting the Console to the Dispenser IC BOX** - Connect the data cable from the “PUMP CONTROL” connector on the PETROSMART EZ console to the connector marked (#3) on the dispenser interconnect box. Refer to Fig. 1.
5. **Connecting the Dispenser IC Box to the CRIND CREDIT CARD MODULE IC Box** - Connect the data cable from the(#1) connector on the Dispenser IC Box to the (#1) connector on the CRIND CREDIT CARD MODULE IC box. Refer to Fig. 1.
6. **The console is powered by a separate “plug-in”**, AC Adaptor, power supply. With the PetroSmart EZ Console turned off, connect the power module to the UPS (Un-interruptible Power Supply) which is supplied with each system.

Refer to the PetroSmart EZ console, programming/operators guide on how to program the console.

10. Important Notes:

1. **TURNING THE SYSTEM OFF:** It is not recommended or necessary to turn OFF the dedicated system breaker that supplies power to the PETROSMART EZ-TM95 board during the time the store/station is closed. Simply turning the console OFF/ON key to the OFF position after all hoses have been de-authorized, along with following the dispenser power down sequence, will prevent fuel from being dispensed.
2. All + and - wire connections between the PETROSMART EZ, MPC-TM95 IC board, the MPCTM84E board and the dispensers must be 18 gauge or larger.
3. All AC wires must be 14 gauge or larger.
4. Use cable ties to keep the data cable in place from the console to the interconnect box if conduit is not used.
5. If the PETROSMART EZ cable is put through a conduit, use 2" minimum to allow room for the connectors on the cable. Do not cut connectors from the PETROSMART EZ cable to use smaller conduit. Do not put PETROSMART EZ cable conduit underground. PETROSMART EZ data cables are not designed to operate under these conditions and will not be covered under warranty.
6. Do not use wire nuts on any grounding connections. Make all connections with compression connectors (crimp or split lug).
7. If the console or dispenser power comes from a sub-panel, all ground wires must end at the main electrical service panel ground.
8. There must be no more than 1 ohm resistance between Neutral and Earth Ground.
9. Do not use old or used wire for dispenser wire connections.
10. Use rigid metal conduit only. Do not use PVC conduit.
11. Do not route mercury vapor, canopy light wiring, or other unrelated wiring through the dispenser wiring conduit.
12. Auxiliary relays or contactors **MUST BE** used in the motor circuit! Refer to the installation manual of the dispenser for complete installation requirements, drawings, and special notes.
13. Wiring for dispensers, PETROSMART EZ for GILBARCO IC box, and other control boxes should all be on the same phase from the service panel, or erratic operation/communication could result.
14. In the interest of everyone's safety, all persons involved in the operation of this system should be made aware of a proper power-down sequence for all components used to dispense flammable products.

11. Specifications

DIMENSIONS

PETROSMART EZ Console 8" W x 4-1/2" H x 9-3/4" D
PETROSMART EZ Dispenser IC Box 10" W x 11-1/2" H x 4-3/4" D
PETROSMART EZ CRIND credit card module IC Box 10" W x 11-1/2" H x 4-3/4" D

WEIGHTS

PETROSMART EZ Console 7 lbs. PETROSMART EZ
IC Box for GILBARCO 8 lbs. PETROSMART EZ Cable (25
ft)..... 2 lbs.

NOTE: The above weights do not include shipping cartons or packing materials.

PERIPHERAL INTERFACE INSTALLATION

In compliance with the UL regulations and standards that apply to the Petroleum Industry, the following information establishes installation parameters for the use of peripheral equipment with the PETROSMART EZ Control Console.

1. Any peripheral equipment must be UL listed.
2. Any peripheral equipment must have an Electronics Industry Association (EIA) Standard RS232C or RS-422A communications interface (whichever is appropriate for the application).
3. Any peripheral equipment must not be installed in or above a hazardous location.
4. The peripheral interconnection cable must be either UL Style 1061 or 2462 suitable for interconnection of electronic equipment.

TRIANGLE MICROSYSTEMS, INC.

WARRANTY AND LIMITATIONS OF REMEDIES

1. Seller warrants that the equipment shall be free of defective parts and workmanship for a period of one (1) year commencing on the day of the invoice from the Seller. Seller's salesman, distributors, representatives, or agents may have made oral statements about the equipment described herein. Such statements do not constitute warranties, shall not be relied on by the buyer and are not part of this contract of sale. **EXCEPT AS SET FORTH ABOVE, SELLER MAKES NO WARRANTY, EXPRESS OR IMPLIED, TO BUYER OR ANY OTHER PERSON AS TO THE EQUIPMENT'S FITNESS FOR A PARTICULAR**

PURPOSE, MERCHANTABILITY, DESIGN, CONDITION OR ANY OTHER ASPECT OF THE EQUIPMENT WHICH IS THE SUBJECT OF THIS CONTRACT OF SALE, ITS COMPONENTS,

WORKMANSHIP AND MATERIALS, BUYER TAKES AND ACCEPTS THE EQUIPMENT AS IS. By reason of his acceptance of delivery of the equipment, Buyer agrees that the equipment is in proper operating order, conforms to the Buyer specifications and the terms and conditions of the contract of sale, and has accepted the equipment in its condition on delivery as the equipment described herein.

2. Buyer's remedies for damages due to breach of the warranty set forth herein shall be limited to repair or replacement of non-conforming goods or parts within the aforesaid time period of one (1) year. **LABOR, TRANSPORTATION, AND TRAVEL ARE NOT COVERED BY THE WARRANTY.** The parties agree that the Buyer's sole and exclusive remedy against the Seller shall be for the repair or replacement of defective parts or goods as provided herein. Buyer agrees that no other remedy, including but not limited to incidental or consequential loss, shall be available to it. Seller further disclaims liability for any loss, damage or injury to any person as a result of any defects, latent or otherwise, in the equipment whether arising from the Seller's negligence, application of the law of strict liability, or breach of warranty.
3. This warranty is automatically void and of no effect in the event of defect, damage, injury or failure of the equipment due to any of the following causes: Acts of God; improper installation; failure to maintain the equipment in accordance with the Seller's instructions; use of the equipment in any manner other than the use for which the Seller has designed and intended the equipment; attempt to install, repair or replace the equipment by any person other than the Seller's authorized employees or agents; modifications or changes to the equipment of any kind of nature; excessive or improper usage and electrical burnouts or surges.
4. Our service policy is to repair and return warranted equipment, or to exchange for re-manufactured components. **We do send out new parts and take back old or used ones at no charge.** During the warranty period, defective TMS components may be returned freight prepaid to Triangle MicroSystems, Inc. TMS will repair or replace, solely at our discretion, at no charge, and return via ground shipment freight prepaid, such components that are judged to be defective in materials or workmanship. **Please note that a repair under warranty does not extend or renew the original warranty period.**
5. This writing contains the final expression of the parties' warranty agreement and is a complete and exclusive statement of the terms of the agreement.